

RSP WALL. Componentes.

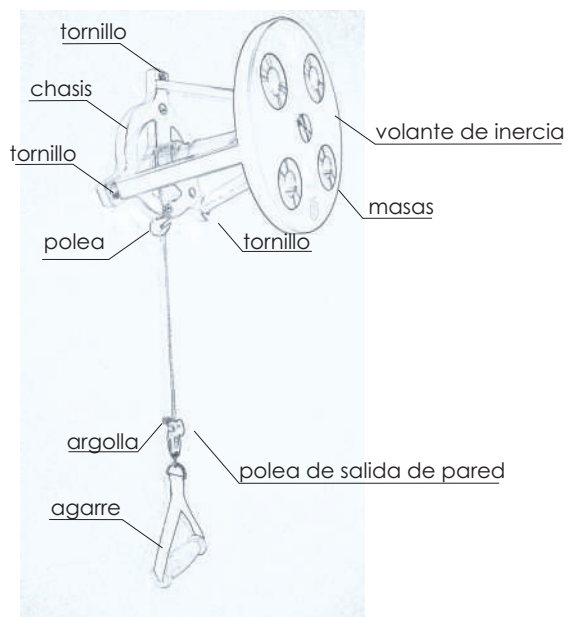

x1

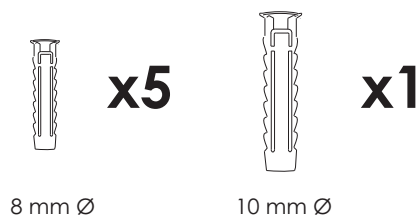
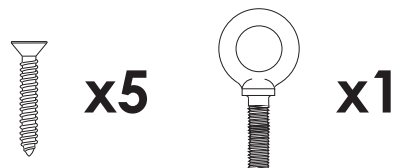

RSP WALL. Instalación.

1.

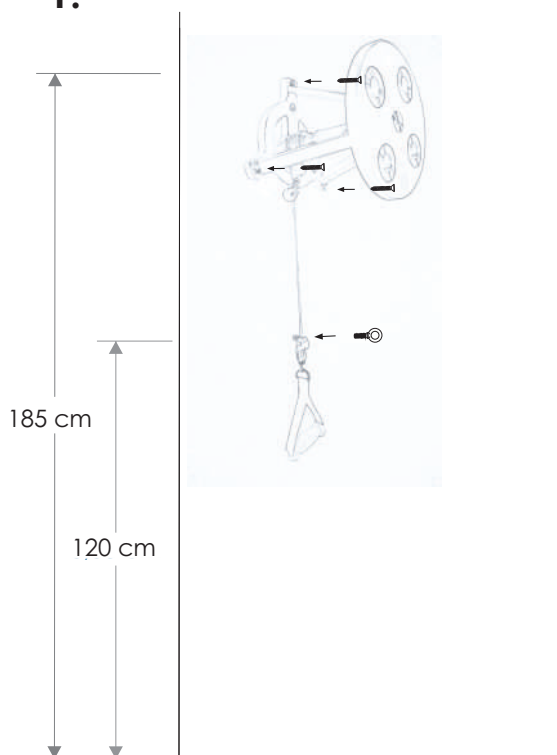

Colocar la parte de arriba de la máquina a una altura aproximada de 185 cm
La polea de salida de pared se coloca a 120 cm del suelo.

2.



Colocación masas:

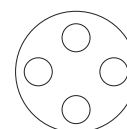

sin masas

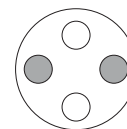

2 masas

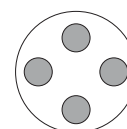

4 masas

Hacer tres agujeros en la pared a la altura indicada, introducir primero los tacos y atornillar los tornillos a la pared, a continuación hacer un agujero para la polea de salida de pared a la altura indicada, colocar el taco grande y el cáncamo.